

VIKING HARDWARE



WASHROOM PRODUCTS BROCHURE

GRAB RAILS

SUPPORT RAILS

SHOWER SEATS

SHOWER RAILS

ACCESSORIES

GRIMSBY BRANCH

TEL. 01472 241212

grimsbysales@vikinghardware.com

HULL BRANCH

TEL. 01482 221231

hullsales@vikinghardware.com

SCUNTHORPE BRANCH

TEL. 01724 850583

scunthorpesales@vikinghardware.com

www.vikinghardware.com



Single Arm Hinged Support Rail

- Stainless Steel for use in wet or damp areas. Mild Steel for use in dry areas.
- 35mm tubular construction for superior strength and confidence.
- Hinged rails are tested to 170kg in vertical and 45 degree positions.
- Die-cast Aluminium Backplate for strength and rigidity.



White

MS	760mm	33300
+	with Toilet Roll Holder	
MS	760mm	33625



Blue - RAL 5011

SS	760mm	33652
----	-------	-------

Other finishes

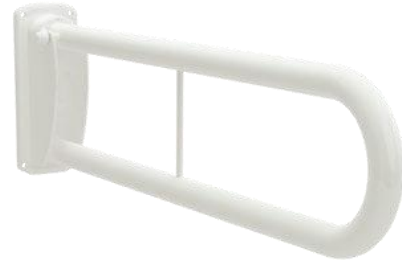
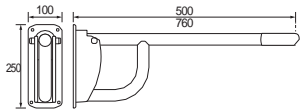

Double Arm Hinged Support Rail

- Mild Steel for use in dry areas.
- 35mm tubular construction for superior strength and confidence.
- Hinged rails are tested to 170kg in vertical and 45 degree positions.
- Die-cast Aluminium Backplate for strength and rigidity.



White

MS	760mm	33800
+	with Toilet Roll Holder	
MS	760mm	34700



Blue - RAL 5011

MS	760mm	33801
----	-------	-------

Other finishes

with Toilet Roll Holder

MS	760mm	34760
----	-------	-------

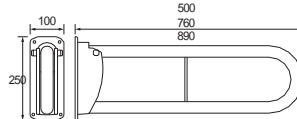

Other finishes



- Stainless Steel for use in wet or damp areas.
- 35mm tubular construction for superior strength and confidence.
- Hinged rails are tested to 170kg in vertical and 45 degree positions.
- Drop Down Leg can be adjusted to 680, 700, and 750mm heights with further micro adjustment of 40mm.
- Die-cast Aluminium Backplate for strength and rigidity.

Single Arm Hinged Support Rail with Drop Down Leg



Blue - RAL 5011

SS	760mm	33662
----	-------	-------

Other finishes



White Polyester

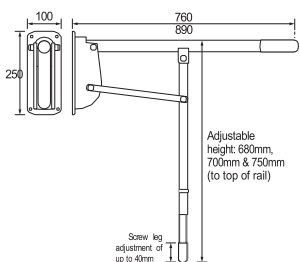

- Mild Steel for use in dry areas.
- 35mm tubular construction for superior strength and confidence.
- Hinged rails are tested to 170kg in vertical and 45 degree positions.
- Drop Down Leg can be adjusted to 680, 700, and 750mm heights with further micro adjustment of 40mm.
- Die-cast Aluminium Backplate for strength and rigidity.

Double Arm Hinged Support Rail with Drop Down Leg



White

MS	760mm	33920
----	-------	-------



Blue - RAL 5011

MS	760mm	33945
----	-------	-------

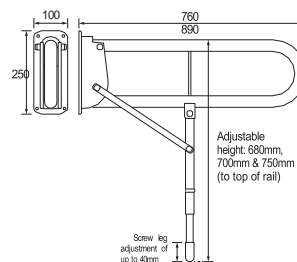



Double Arm Hinged Support Rail

- Stainless Steel for use in wet or damp areas.
- 35mm tubular construction for superior strength and confidence.
- Hinged rails are tested to 170kg in vertical and 45 degree positions.
- Fully Stainless Steel Backplate for ultimate durability.

● Sateen Polish

SS 760mm 34910

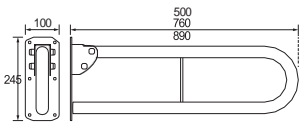

Other finishes

- Mirror Polish
- White Polyester
- RAL Colour



Fully Stainless Steel Double Arm Hinged Support Rail

- Stainless Steel for use in wet or damp areas.
- 35mm tubular construction for superior strength and confidence.
- Hinged rails are tested to 170kg in vertical and 45 degree positions.
- Fully Stainless Steel Backplate for ultimate durability.

● Mirror Polish

SS 760mm 35037

Other finishes

- Sateen Polish



Friction Single Arm Hinged Support Rail

● Mirror Polish

SS 760mm 32901MP

- Easy to use friction action.
- Fully stainless steel backplate for ultimate durability.
- Strong tubular construction.
- Ideal for use in wet or damp areas.
- Tested to 120kg in vertical and 45 degree positions. This does not include customer fixings.

- Other finishes
- Sateen Polish
 - White Polyester
 - RAL Colour

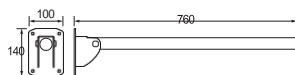

Friction Shower Seat

● Mirror Polish

SS 760mm 49879

- Stainless Steel for use in wet or damp areas.
- 35mm tubular construction for superior strength and confidence.
- Hinged rails are tested to 170kg in vertical and 45 degree positions.
- Fully Stainless Steel Backplate for ultimate durability.

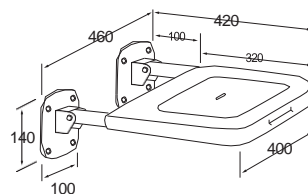

Other finishes

- Sateen Polish
- White Polyester
- RAL Colour

Slotting Action Shower Seat



○
White

SS	without Drop Down Legs	49800
SS	with Drop Down Legs	49725

- Stainless Steel frame with Aluminium backplates.
- Seats with drop down legs have adjustable height: 490-550mm (to top of seat) and additional feet adjustment of up to ± 20 mm.
- Load tested to a vertical drop weight of 170kg. This does not include customer fixings.
- Plastic seat, removable for easy cleaning.
- White seat as standard. Black and Blue RAL 5011 seats also available.

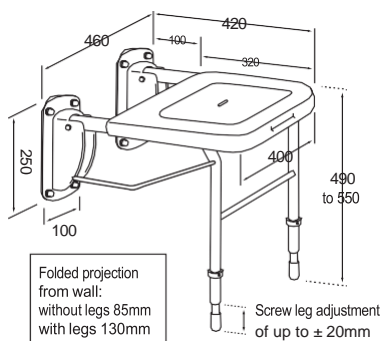

Other finishes
RAL Colour

Padded Shower Seat with Arms and Backrest



○
White

SS	with Drop Down Legs	49970
----	---------------------	-------

- Adjustable height of 457-510mm (to top of seat) with additional feet adjustment of up to 20mm.
- Can be folded into the upright position.
- Tested to a vertical drop weight of 190kg. This does not include customer fixings.

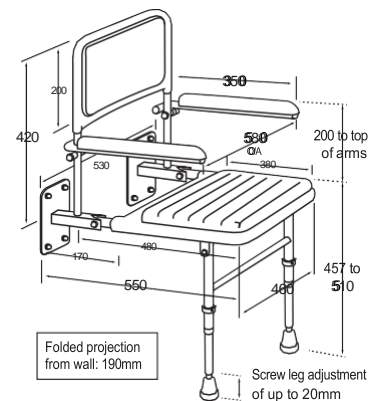

Compact Shower Seat



○
White

- Adjustable height: 460-550mm (to top of seat) with additional feet adjustment of up to ± 20 mm.
- Can be folded into the upright position.
- Maximum recommended load 190kg. This does not include customer fixings.
- Plastic seat, removable for easy cleaning.
- Backplate bolt holes are drilled for M8 bolts. (Fixings not supplied)

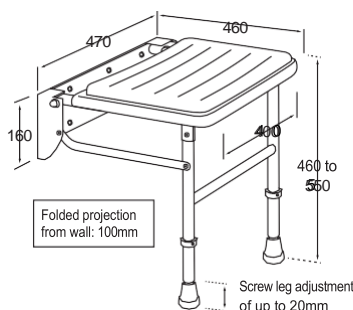

SS	with Padded Seat	49950
SS	with Plastic Seat	49940

25mm Grab Rail

- Mild Steel for use in dry areas. Stainless Steel for use in wet or damp areas.
- 25mm tube diameter for slender hands and added elegance.
- Strong tubular construction with robust welded flanges for lasting strength and performance.
- Optional ribbed grip for extra stability and confidence.
- Available with concealed fixings.

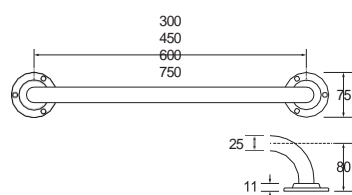

Other finishes

- Mirror Polish
- Sateen Polish
- RAL Colour



- White
- Chrome Plate

MS	300mm	15100	13000
MS	450mm	15300	13200
MS	600mm	15400	13300
+ with Ribbed Grip			
MS	300mm	15800	13700
MS	450mm	16000	13900

35mm Grab Rail

- Mild steel for use in dry areas. Stainless Steel for use in wet or damp areas.
- 35mm tube diameter for superior strength and confidence.
- Strong tubular construction with robust welded flanges for lasting strength and performance.
- Optional ribbed grip for extra stability and confidence.
- Available with concealed fixings.

Other finishes

- RAL Colour

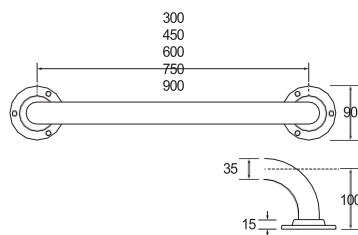

- White
- Blue - RAL 5011
- Mirror Polish
- Sateen Polish

MS	300mm	21800	21801	21400	NA
MS	450mm	21900	21901	21500	NA
MS	600mm	22000	22001	21600	NA
MS	900mm	22110	22111	21750	NA
SS	300mm	30700	31260	29500	30050
SS	450mm	30800	31261	29600	30055
SS	600mm	31000	31262	29800	30060
+ with Concealed Fixings					
MS	600mm	22000C	22001C	NA	NA

Flat End Grab Rail



- White

Straight Grab Rail		
MS	300mm	12100
MS	450mm	12200
MS	600mm	12300
Offset Grab Rail		
MS	300mm	12700
MS	450mm	12800

- Mild Steel for use in dry areas.
- Available in polyester coated finish or white LDPE (dipped plastic coating).

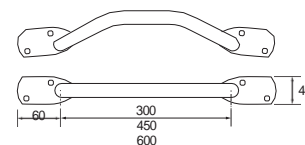



Fluted Plastic Grab Rail

- Fluted Plastic grab rail.
- Concealed fixings.
- Available in white or Blue RAL 5011 only.



Fluted Plastic Grab Rail	
300mm	32640
450mm	32650
600mm	32660



Fluted Plastic Grab Rail	
300mm	32635
450mm	32636
600mm	32637

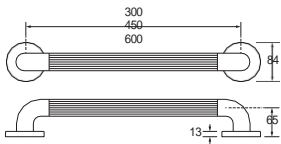

Newell Rail



Newell Rail		
MS	Left Handed	43700
Newell Rail		
MS	Right Handed	43900

- Mild Steel for use in dry areas.
- Strong tubular construction with robust welded flanges for lasting strength and performance.

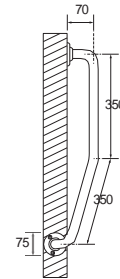

L Shaped Grab Rail



Left Handed		
MS	400 x 800mm	39520
Right Handed		
MS	400 x 800mm	39550

- Mild Steel for use in dry areas. Stainless Steel for use in wet or damp areas.
- Strong tubular construction with robust welded flanges for lasting strength and performance.
- Optional ribbed grip for extra stability and confidence.

Other finishes

- Mirror Polish
- Sateen Polish
- Chrome Plate
- RAL Colour

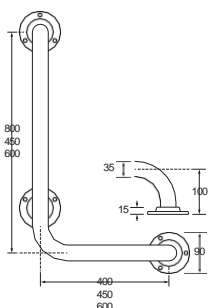

Wall to Floor Rail

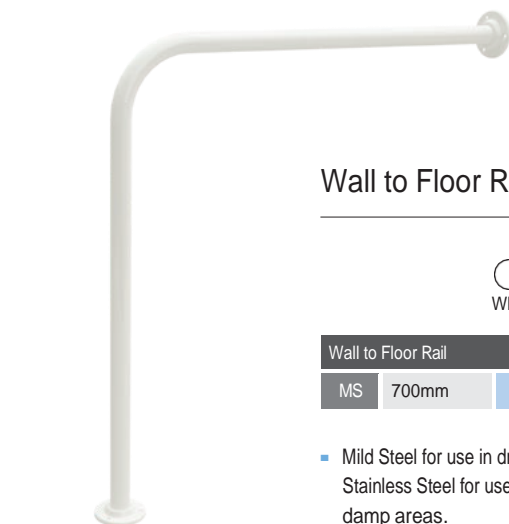

Wall to Floor Rail		
MS	700mm	37300

- Mild Steel for use in dry areas. Stainless Steel for use in wet or damp areas.
- Strong tubular construction with robust welded flanges for lasting strength and performance.
- Optional ribbed grip for extra stability and confidence.

Other finishes

- Mirror Polish
- Sateen Polish
- RAL Colour

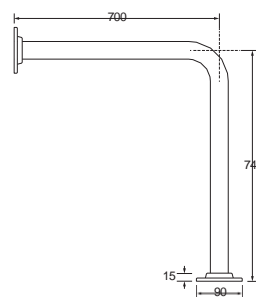



Towel Ring

Chrome Plate	61300
--------------	-------

- Mild Steel.
- 150mm diameter towel ring.



Double Robe Hook

Chrome Plate	53500
--------------	-------

- Zinc Die-cast
- (H) 55mm.



Knowle Single Toilet Roll Holder

SS	Mirror Polish	60300MP
----	---------------	---------

- Curved to match the Knowle Grab Rail range with elegant over sized end cap retains the toilet roll.



Medium Toilet Roll Holder

Chrome Plate	50100
--------------	-------

- Zinc Die-cast. Black plastic roller.
- (W) 136mm x (D) 76mm.



Heavy Toilet Roll Holder

Chrome Plate	50500
--------------	-------

- Zinc Die-cast. Black plastic roller.
- (W) 145mm x (D) 78mm.



Locking Toilet Roll Holder

Chrome Plate	50900
--------------	-------

- Zinc Die-cast. Wooden roller.
- Allen key supplied.
- (W) 145mm x (D) 78mm.



Aluminium Toilet Roll Holder

Brushed Aluminium	51210
-------------------	-------

- Black plastic roller.
- (W) 136mm x (D) 83mm.



Towel Rail

- Mild Steel for use in dry areas.

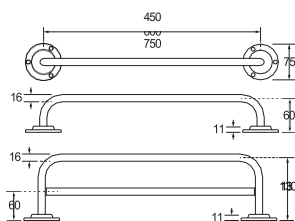

16mm Single Towel Rail		
MS	450mm	57400
MS	600mm	57500
16mm Double Towel Rail		
MS	600mm	58400

○ Chrome Plate

○ Other finishes
○ White Polyester



Ball End Towel Rail

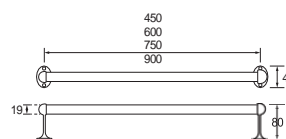

19mm Towel Rail		
MS	450mm	55000
MS	600mm	55100
MS	750mm	55200

○ Chrome Plate

- Mild Steel tube with Zinc Die-cast brackets.
- 25mm available on request.

Shower Rail

- We recommend that only stainless steel curtain rails be used in wet or damp areas. Mild Steel for use in dry areas.
- Curtain Rails are modular and are joined using black connectors to aid delivery and installation (Chrome Plate has two connectors, other finishes have one).

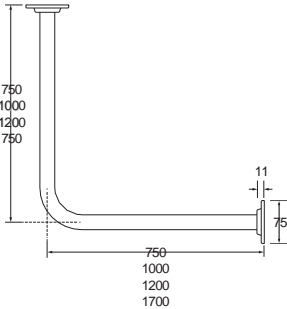

- White
- Chrome Plate*
- Mirror Polish

MS	750mm x 1700mm	65800	65500	NA
MS	1200mm x 1200mm	65905	65610	NA
SS	1200mm x 1200mm	65962	NA	65935

* Chrome Flanges

Other finishes

- Sateen Polish

Ceiling Stay

White Polyester		
SS	500mm	66120

Mirror Polished		
SS	500mm	66110

- Ceiling stays are recommended on larger sizes and in shower scenarios.
- Ceiling Stays are 500mm but can be manufactured to customer specification.

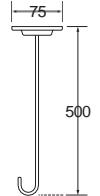

Other finishes

- Sateen Polish



Shower Curtain

Plastic Satin Finish	
914 x 1830mm	65350
1830 x 1830mm	65360
Polyester 4oz Weighted	
1830 x 1830mm	65390

- 914mm curtains require 6 hooks.
- 1830mm satin plastic curtains require 10 hooks.
- 1830mm polyester curtains require 12 hooks.
- Please note, curtain hooks are not included and must be ordered separately.
- Suitable for wet or dry areas.



Curtain Hooks

Brass Curtain Hooks	
Chrome Plate	66200
Plastic Curtain Hooks	
White Plastic	66180

- Brass for use with 25mm tube.
- Plastic for use with 25mm and 35mm tube.



35mm Back Rest Rail

- White
- Blue - RAL 5011
- Chrome Plate
- Sateen Polish

MS	48605	48606	48505	NA
SS	49200	49210	NA	49110

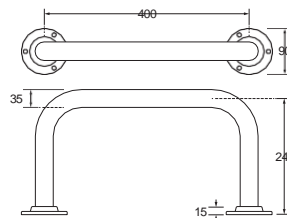

- Stainless Steel for use in wet or damp areas. Mild Steel for use in dry areas.
- Strong tubular construction with robust welded flanges for lasting strength and performance.

Other finishes

- Mirror Polish



Back Rest Cushion

Waterproof Cushion	49702
--------------------	-------

- Water resistant foam.
- 355mm x 160mm x 35mm.



35mm Yardley Grab Rail

- Minimum projection distance from the wall for when space is at a premium.
- Stylish, low profile cover plates.
- Perfectly shaped machined support legs.



SS	300mm	19000MP
SS	450mm	19001MP
SS	600mm	19002MP

- Other finishes
- Sateen Polish
 - White Polyester
 - RAL Colour

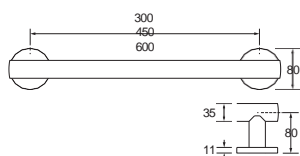

35mm Yardley 3 Flange Grab Rail

- Minimum projection distance from the wall for when space is at a premium.
- Stylish, low profile cover plates.
- Perfectly shaped machined support legs.



SS	1500mm	19075MP
----	--------	---------

- Other finishes
- Sateen Polish
 - White Polyester
 - RAL Colour

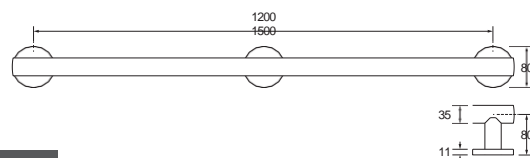

Matt Black Products



35mm Yardley Grab Rail

- Minimum projection distance from the wall for when space is at a premium.
- Stylish, low profile cover plates.
- Perfectly shaped machined support legs.



SS	300mm	19000CO
SS	450mm	19001CO
SS	600mm	19002CO

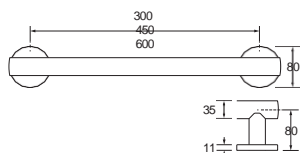

Yardley Single Toilet Roll Holder

- Matches the Yardley Grab Rail range.
- Elegant over sized end cap retains the toilet roll.



SS	Single TRH	60200CO
----	------------	---------

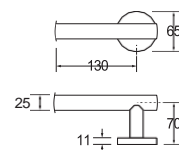

Corner WC Doc M Pack - Low Level

Low Level Pack includes:

- 1x 760mm Double Arm
- 1x Backrest* 240 x 400 x 240mm
- 3x/4x Grab Rails 600mm x 35mm



Sateen Polish

3 Rail Doc M Pack	
SS	82010
4 Rail Doc M Pack	
SS	83130

Other finishes	
	Mirror Polish
	White Polyester
	RAL Colour



* Backrest cushions are not supplied as part of the pack and must be ordered as an optional extra.

British Standard 8300:2009, Building Regulations 2000 Access To and Use of Buildings (2004 Edition)

Bespoke Products

We normally deal with three sorts of bespoke requests, product variants, new/bespoke designs and non-standard colours. These products due to their bespoke nature may incur additional engineering charges, but we will make these charges clear in your quotation.

Product Variants

The most common request is for a variation to an existing product. This includes minor specification changes for example - a little longer grab rail, a slightly different angle or a change of position to the fixturing. In most of these cases we can provide an answer same day, and the price is likely to be similar to our standard product ranges.

Bespoke Design

Using our flange and tube system we have the ability to bend, add flanges and add ribbing which means we can manufacture any number of bespoke configurations. Working with our designers you can commission a completely unique rail to fit your scenario.

Bespoke Colours

We are able to manufacture most of our products in a RAL colour of your choosing. For any RAL colours other than White RAL 9016 and Blue RAL 5011 there is a coating surcharge of £20 for small quantities. Where this applies you will be advised at the point of ordering. Larger quantities will not attract any coating surcharge.

RAL Colours

This list is not exhaustive, please contact us if the required colour is not listed.

RAL 1004 Dark Golden Yellow	RAL 1007 Chrome Yellow	RAL 1018 Zinc Yellow	RAL 1023 Traffic Yellow
RAL 3000 Flame Red	RAL 3001 Signal Red	RAL 3003 Ruby Red	RAL 3020 Traffic Red
RAL 5002 Ultramarine Blue	RAL 5005 Signal Blue	RAL 5011 Steel Blue	RAL 5017 Traffic Blue
RAL 6002 Leaf Green	RAL 6005 British Racing Green	RAL 6016 Turquoise Green	RAL 6018 Yellow Green
RAL 7001 Silver Grey	RAL 7004 Signal Grey	RAL 7015 Slate Grey	RAL 7024 Graphite Grey
RAL 9004 Signal Black	RAL 9005 Jet Black	RAL 9016 Traffic White	RAL 9017 Traffic Black